

**INDUSTRIAL CONTROL**

**PRESENSE PHOTOELECTRIC SENSORS**

## VLP25 Series

### Benefits

- Comfortable and fast teaching procedure
- Comfortable thanks to display LEDs visible from all sides
- Maximum flexibility thanks to uniform housing design
- Sealed housing for absolute impermeability
- Exact positioning and detection of small parts
- Long detection distance
- Excellent performance
- Wide range of models for different applications type

### Diffuse sensor -

- Precise detection
- Detects objects with various shapes and surfaces even more reliably
- Visible or Infrared LED for all accuracy requirements
- Range of up to 1 m
- Response times < 1 ms
- Axial optics
- Flush installation
- Compact body for space saving

### Retro-reflective sensors

- Visible and Infrared LED
- Range of up to 12 m
- Response times < 1 ms
- Detection of transparent objects
- Axial optics
- Flush installation
- Compact body for space saving

### Through beam sensors

- Infrared light source
- Range of up to 12 m
- Regulation of transmit power via potentiometer
- Axial optics
- Compact body for space saving

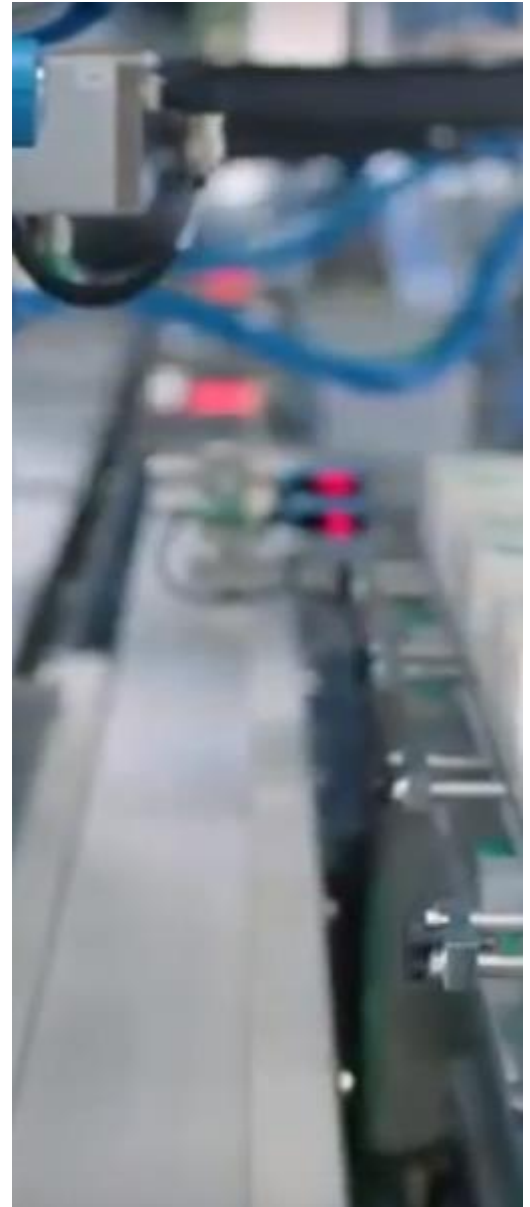

## Diffuse photoelectric proximity sensors series

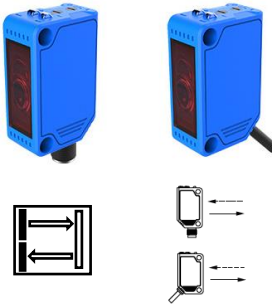

### PRODUCT HIGHLIGHTS

- Excellent performance for numerous applications
  - ✓ Through-beam type: up to 12m
  - ✓ Retroreflection type: up to 3m
  - ✓ Diffuse reflection type: up to 1m
- AC type and DC type available
- Ultra-small sensor: 10mm\*20mm\*30mm.
- Robust plastic housings (IP 65)
- High device availability in industrial environments, using integrated IC manufacturing, strong anti-jamming performance.
- Range between -25 °C ... +55 °C

Optical data		Functions	
<b>Sensing distance</b>	See Selection Table	<b>Indicator LED, green</b>	Operating voltage indicator
<b>Type of light</b>	See Selection Table	<b>Indicator LED, yellow</b>	Switching output indicator
<b>Light spot size</b>	See Selection Table	<b>Sensitivity adjustment</b>	Via potentiometer
<b>Emitting element</b>	Red LED (peak emission wavelength 630nm, modulated) Infrared LED (peak emission wavelength 850 nm, modulated)	<b>Adjustment possibilities</b>	N.O./N.C. via control input (IN)
<b>Minimum sensing object</b>	<ul style="list-style-type: none"> <li>• Through-beam type: Ø18mm or more opaque object (Setting distance between emitter and receiver is 12m)</li> <li>• Retroreflective type: Ø54mm or more opaque, translucent or transparent object(note2,4)</li> <li>• Diffuse type: Opaque, translucent or transparent object (note 1)</li> </ul>	<b>Default settings</b>	Max. scanning distance and N.O.
Electrical data		Mechanical data	
<b>Operating voltage, +U<sub>B</sub></b>	10 ~30V/DC	<b>Dimensions</b>	See dimensional drawings
<b>No-load current, I<sub>0</sub></b>	≤ 30 mA	<b>Enclosure rating</b>	IP 65
<b>Output current, I<sub>e</sub></b>	≤ 100 mA	<b>Material, housing</b>	ABS
<b>Protective circuits</b>	Reverse-polarity protection, U <sub>B</sub> / short-circuit protection, 500V AC for one min. between all supply terminals connected together and enclosure	<b>Material, front screen</b>	PMMA
<b>Switching output, Q</b>	PNP/NPN	<b>Type of connection</b>	See Selection Table
<b>Output function</b>	N.O./N.C	<b>Ambient temperature: operation</b>	-25 ... +55 °C
<b>Switching frequency, f (ti/tp 1:1)</b>	≤ 1000 Hz	<b>Weight (plug device)</b>	Approx. 20 g
<b>Response time</b>	≤ 1 ms	<b>Weight (2M cable device)</b>	Approx. 60 g
<b>Control input: Potentiometer</b>	+ = NC - = NO	<b>Distance Control: Potentiometer</b>	0.....Distance
Environmental resistance		EMC	
<b>Population degree</b>	3 (industrial environment)	<b>EMC</b>	EN60947-5-2
<b>Protection</b>	IP65(IEC)	<b>Vibration resistance</b>	10~55Hz frequency,0.5mm amplitude in X,Y and Z directions for 1.5 hours each
<b>Temperature</b>	-25 ~+55°C(No dew condensation or icing allowed), Storage: -40 ~+70°C	<b>Shock resistance</b>	294m/s acceleration (30G approx.) in X, Y and Z directions for three times each
<b>Humidity</b>	50% RH (70°C)		
<b>Light intensity</b>	Incandescent light: less than 5,000Lux/Sunlight: less than 10,000Lux		

(1) With connected IP65 plug

(2) The default measure temperature conditions is +23 °C, when didn't specify measure condition.

(3) Detection range and objects of Retroreflective type sensor apply to TD-08 reflector.

(4) Detection range and hysteresis of diffuse reflective type sensor apply to detection objects of gloss white paper (200x200mm).

(5) Please use actual sensor to validate testing effect, before testing transparent or translucent object.

Type	Sensing distance (S <sub>n</sub> )	Light source	Power supply	Switching output	Switching mode	Connectio type	Housing Material	Part Number
Diffuse type	0 ... 1000 mm	Red light	10 ~30V/DC	PNP	NO/NC	Plastic plug, M8, 4-pin	Plastic	VLP25-D-PSD-1CR
Diffuse type	0 ... 1000 mm	Red light	10 ~30V/DC	NPN	NO/NC	Plastic plug, M8, 4-pin	Plastic	VLP25-D-NSD-1CR
Diffuse type	0 ... 1000 mm	Red light	10 ~30V/DC	PNP	NO/NC	Cable, 2 m, 4-wire	Plastic	VLP25-D-PSD-1YR
Diffuse type	0 ... 1000 mm	Red light	10 ~30V/DC	NPN	NO/NC	Cable, 2 m, 4-wire	Plastic	VLP25-D-NSD-1YR
Diffuse type	0 ... 1000 mm	Infrared light	10 ~30V/DC	PNP	NO/NC	Plastic plug, M8, 4-pin	Plastic	VLP25-D-PSD-1CI
Diffuse type	0 ... 1000 mm	Infrared light	10 ~30V/DC	NPN	NO/NC	Plastic plug, M8, 4-pin	Plastic	VLP25-D-NSD-1CI
Diffuse type	0 ... 1000 mm	Infrared light	10 ~30V/DC	PNP	NO/NC	Cable, 2 m, 4-wire	Plastic	VLP25-D-PSD-1YI
Diffuse type	0 ... 1000 mm	Infrared light	10 ~30V/DC	NPN	NO/NC	Cable, 2 m, 4-wire	Plastic	VLP25-D-NSD-1YI

## Retroreflective photoelectric proximity sensors series



### PRODUCT HIGHLIGHTS

- Excellent performance for numerous applications
  - ✓ Through-beam type: up to 12m
  - ✓ Retroreflection type: up to 3m
  - ✓ Diffuse reflection type: up to 1m
- AC type and DC type available
- Ultra-small sensor: 10mm\*20mm\*30mm.
- Robust plastic housings (IP 65)
- High device availability in industrial environments, using integrated IC manufacturing, strong anti-jamming performance.
- Range between -25 °C ... +55 °C

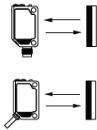

Optical data		Functions	
<b>Sensing distance</b>	See Selection Table	<b>Indicator LED, green</b>	Operating voltage indicator
<b>Type of light</b>	See Selection Table	<b>Indicator LED, yellow</b>	Switching output indicator
<b>Light spot size</b>	See Selection Table	<b>Sensitivity adjustment</b>	Via potentiometer
<b>Emitting element</b>	Red LED (peak emission wavelength 630nm, modulated) Infrared LED (peak emission wavelength 850 nm, modulated)	<b>Adjustment possibilities</b>	N.O./N.C. via control input (IN)
<b>Minimum sensing object</b>	<ul style="list-style-type: none"> <li>• Through-beam type: Ø18mm or more opaque object (Setting distance between emitter and receiver is 12m)</li> <li>• Retroreflective type: Ø54mm or more opaque, translucent or transparent object(note2,4)</li> <li>• Diffuse type: Opaque, translucent or transparent object (note 5)</li> </ul>	<b>Default settings</b>	Max. scanning distance and N.O.
Electrical data		Mechanical data	
<b>Operating voltage, +U<sub>s</sub></b>	10 ~30V/DC	<b>Dimensions</b>	See dimensional drawings
<b>No-load current, I<sub>0</sub></b>	≤ 30 mA	<b>Enclosure rating</b>	IP 65
<b>Output current, I<sub>e</sub></b>	≤ 100 mA	<b>Material, housing</b>	ABS
<b>Protective circuits</b>	Reverse-polarity protection, U <sub>s</sub> / short-circuit protection, 500V AC for one min. between all supply terminals connected together and enclosure	<b>Material, front screen</b>	PMMA
<b>Switching output, Q</b>	PNP/NPN	<b>Type of connection</b>	See Selection Table
<b>Output function</b>	N.O./N.C	<b>Ambient temperature: operation</b>	-25 ... +55 °C
<b>Switching frequency, f (ti/tp 1:1)</b>	≤ 1000 Hz	<b>Weight (plug device)</b>	Approx. 20 g
<b>Response time</b>	≤ 1 ms	<b>Weight (2M cable device)</b>	Approx. 60 g
<b>Control input: Potentiometer</b>	+ = NC - = NO	<b>Distance Control: Potentiometer</b>	0.....Distance
Environmental resistance		EMC	
<b>Population degree</b>	3 (industrial environment)	<b>EMC</b>	EN60947-5-2
<b>Protection</b>	IP65(IEC)	<b>Vibration resistance</b>	10~55Hz frequency,0.5mm amplitude in X, Y and Z directions for 1.5 hours each
<b>Temperature</b>	-25 ~+55°C(No dew condensation or icing allowed), Storage: -40 ~+70°C	<b>Shock resistance</b>	294m/s acceleration (30G approx.) in X, Y and Z directions for three times each
<b>Humidity</b>	50% RH (70°C)		
<b>Light intensity</b>	Incandescent light: less than 3,000Lux/Sunlight: less than 10,000Lux		

(1) With connected IP 65 plug

(2) The default measure temperature conditions is +23 °C, when didn't specify measure condition.

(3) Detection range and objects of Retroreflective type sensor apply to TD-08 reflector.

(4) Detection range and hysteresis of diffuse reflective type sensor apply to detection objects of gloss white paper (200x200mm).

(5) Please use actual sensor to validate testing effect, before testing transparent or translucent object.

Type	Sensing distance (Sn)	Light source	Power supply	Switching output	Switching mode	Connectio type	Housing Material	Part Number
Retroreflective type	0 ... 3000mm	Red light	10 ~30V/DC	PNP	NO/NC	Plastic plug, M8, 4-pin	Plastic	VLP25-D-PSD-3CR
Retroreflective type	0 ... 3000mm	Red light	10 ~30V/DC	NPN	NO/NC	Plastic plug, M8, 4-pin	Plastic	VLP25-D-NSD-3CR
Retroreflective type	0 ... 3000mm	Red light	10 ~30V/DC	PNP	NO/NC	Cable, 2 m, 4-wire	Plastic	VLP25-D-PSD-3YR
Retroreflective type	0 ... 3000mm	Red light	10 ~30V/DC	NPN	NO/NC	Cable, 2 m, 4-wire	Plastic	VLP25-D-NSD-3YR
Retroreflective type	0 ... 3000mm	Infrared light	10 ~30V/DC	PNP	NO/NC	Plastic plug, M8, 4-pin	Plastic	VLP25-D-PSD-3CI
Retroreflective type	0 ... 3000mm	Infrared light	10 ~30V/DC	NPN	NO/NC	Plastic plug, M8, 4-pin	Plastic	VLP25-D-NSD-3CI
Retroreflective type	0 ... 3000mm	Infrared light	10 ~30V/DC	PNP	NO/NC	Cable, 2 m, 4-wire	Plastic	VLP25-D-PSD-3YI
Retroreflective type	0 ... 3000mm	Infrared light	10 ~30V/DC	NPN	NO/NC	Cable, 2 m, 4-wire	Plastic	VLP25-D-NSD-3YI
Retroreflective Polarized	0 ... 4000mm	Infrared light	10 ~30V/DC	PNP	NO/NC	Plastic plug, M8, 4-pin	Plastic	VLP25-D-PZM-P4C
Retroreflective Polarized	0 ... 4000mm	Infrared light	10 ~30V/DC	NPN	NO/NC	Plastic plug, M8, 4-pin	Plastic	VLP25-D-NZM-P4C

(1): The sensing distance of the Retroreflection type is referring to the reflector TD-08. The sensing distance represents the detectable range of the detection object.

## Through-beam photoelectric proximity sensors series

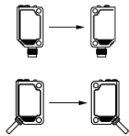

### PRODUCT HIGHLIGHTS

- Excellent performance for numerous applications
  - ✓ Through-beam type: up to 12m
  - ✓ Retroreflection type: up to 3m
  - ✓ Diffuse reflection type: up to 1m
- AC type and DC type available
- Ultra-small sensor: 10mm\*20mm\*30mm.
- Robust plastic housings (IP 65)
- High device availability in industrial environments, using integrated IC manufacturing, strong anti-jamming performance.
- Range between -25 °C ... +55 °C

Optical data		Functions	
<b>Sensing distance</b>	See Selection Table	<b>Indicator LED, green</b>	Operating voltage indicator
<b>Type of light</b>	See Selection Table	<b>Indicator LED, yellow</b>	Switching output indicator
<b>Light spot size</b>	See Selection Table	<b>Sensitivity adjustment</b>	Via potentiometer
<b>Emitting element</b>	Red LED (peak emission wavelength 630nm, modulated) Infrared LED (peak emission wavelength 850 nm, modulated)	<b>Adjustment possibilities</b>	N.O./N.C. via control input (IN)
<b>Minimum sensing object</b>	<ul style="list-style-type: none"> <li>• Through-beam type: Ø18mm or more opaque object (Setting distance between emitter and receiver is 12m)</li> <li>• Retroreflective type: Ø54mm or more opaque, translucent or transparent object(note2,4)</li> <li>• Diffuse type: Opaque, translucent or transparent object (note 5)</li> </ul>	<b>Default settings</b>	Max. scanning distance and N.O.
Electrical data		Mechanical data	
<b>Operating voltage, +UB</b>	10 ~30V/DC	<b>Dimensions</b>	See dimensional drawings
<b>No-load current, I0</b>	≤ 30 mA	<b>Enclosure rating</b>	IP 65
<b>Output current, Ie</b>	≤ 100 mA	<b>Material, housing</b>	ABS
<b>Protective circuits</b>	Reverse-polarity protection, Ua / short-circuit protection, 500V AC for one min. between all supply terminals connected together and enclosure	<b>Material, front screen</b>	PMMA
<b>Switching output, Q</b>	PNP/NPN	<b>Type of connection</b>	See Selection Table
<b>Output function</b>	N.O./N.C.	<b>Ambient temperature: operation</b>	-25 ... +55 °C
<b>Switching frequency, f (ti/tp 1:1)</b>	≤ 1000 Hz	<b>Weight (plug device)</b>	Approx. 20 g
<b>Response time</b>	≤ 1 ms	<b>Weight (2M cable device)</b>	Approx. 60 g
<b>Control input: Potentiometer</b>	+ = NC - = NO	<b>Distance Control: Potentiometer</b>	0.....Distance
Environmental resistance		EMC	
<b>Population degree</b>	3(industrial environment)	<b>Vibration resistance</b>	10-55Hz frequency,0.5mm amplitude in X, Y and Z directions for 1.5 hours each
<b>Protection</b>	IP65(IEC)	<b>Shock resistance</b>	294m/s acceleration (30G approx.) in X, Y and Z directions for three times each
<b>Temperature</b>	-25 ~+55°C(No dew condensation or icing allowed), Storage: -40 ~+70°C		
<b>Humidity</b>	50% RH (70°C)		
<b>Light intensity</b>	Incandescent light: less than 3,000Lux/Sunlight: less than 10,000Lux		

(1) With connected IP 65 plug

(2) The default measure temperature conditions is +23 °C, when didn't specify measure condition.

(3) Detection range and objects of Retroreflective type sensor apply to TD-08 reflector.

(4) Detection range and hysteresis of diffuse reflective type sensor apply to detection objects of gloss white paper (200x200mm).

(5) Please use actual sensor to validate testing effect, before testing transparent or translucent object.

Type	Sensing distance (Sn)	Light source	Power supply	Switching output	Switching mode	Connectio type	Housing Material	Part Number
Through-beam type	0 ... 12m	Red light	10 ~30V/DC	PNP	NO/NC	Plastic plug, M12, 4-pin	Plastic	VLP25-DE-PST-12CR
Through-beam type	0 ... 12m	Red light	10 ~30V/DC	NPN	NO/NC	Plastic plug, M12, 4-pin	Plastic	VLP25-DE-NST-12CR
Through-beam type	0 ... 12m	Red light	10 ~30V/DC	PNP	NO/NC	Cable, 2 m, 4-wire	Plastic	VLP25-DE-PST-12YR
Through-beam type	0 ... 12m	Red light	10 ~30V/DC	NPN	NO/NC	Cable, 2 m, 4-wire	Plastic	VLP25-DE-NST-12YR
Through-beam type	0 ... 12m	Red light	10 ~30V/DC	PNP	NO/NC	Plastic plug, M12, 4-pin	Plastic	VLP25-DE-PST-12CI
Through-beam type	0 ... 12m	Red light	10 ~30V/DC	NPN	NO/NC	Plastic plug, M12, 4-pin	Plastic	VLP25-DE-NST-12CI
Through-beam type	0 ... 12m	Red light	10 ~30V/DC	PNP	NO/NC	Cable, 2 m, 4-wire	Plastic	VLP25-DE-PST-12YI
Through-beam type	0 ... 12m	Red light	10 ~30V/DC	NPN	NO/NC	Cable, 2 m, 4-wire	Plastic	VLP25-DE-NST-12YI

(1): Model marked on the Through-beam type with "E" for the emitter, with "D" for the receiver.

## Mechanical dimensions (mm)

Sensor with M8 connector and integrated cable type

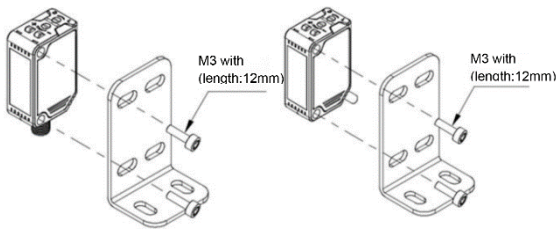
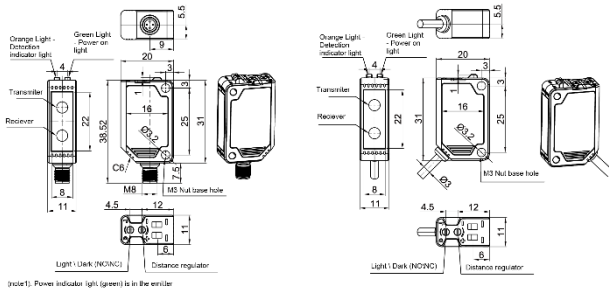

Wiring Diagram

NPN Output type

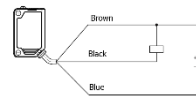

PNP Output type

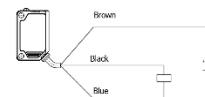

Connector diagram M8 connector

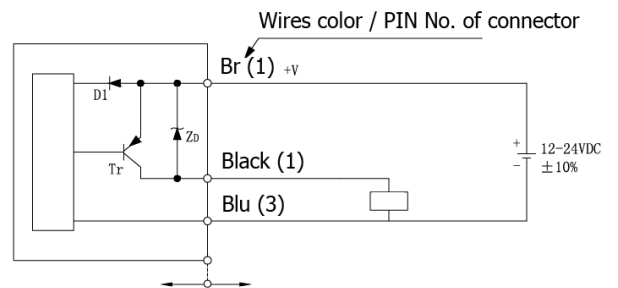

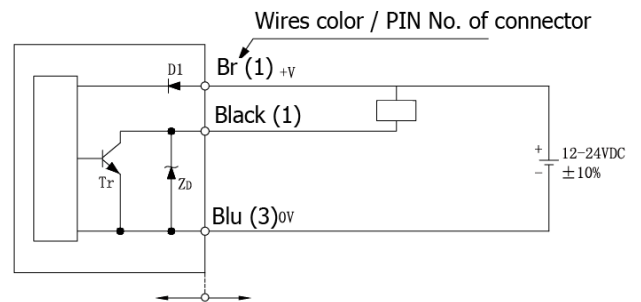

Symbol...D1: Power supply reverse protection diode  
D2: Output connection protection diode  
ZD: Zener diode for surge voltage absorption  
Tr: PNP output transistor





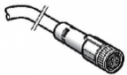

Symbol...D1: Power supply reverse protection diode  
D2: Output connection protection diode  
ZD: Zener diode for surge voltage absorption  
Tr: NPN output transistor

## Options

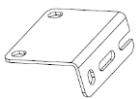
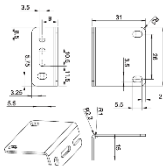
Connect cable (2 cables are required for the Through-beam type)

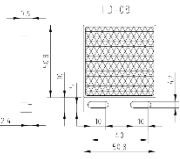
Type	Model	Description		
Suitable for M8 plug-in connector type	Straight type 	V5-SM8-24-C2	Length: 2m	Clamping ring: $\varnothing 9$ mm
		V5-SM8-24-C5	Length: 5m	
	L-shaped type 	V5-SM8-24L-C2	Length: 2m	Cable outer: $\varnothing 4$ mm
		V5-SM8-24L-C5	Length: 5m	

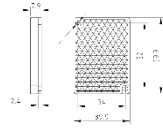
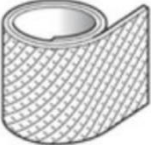
Item	Model	Description
Sensor mounting bracket	VLP25-ZJ-1  	Material: Stainless steel
Reflector	TD-08  	50 x 50mm
	TD-09  	60 x 40mm
Reflective tape	FZ-12 	76 x 2800mm

# CONTACT US

V5 Group Ltd.

Address: Yokneam Illit, Afek 11b, Israel

Web: [www.v5-group.com](http://www.v5-group.com)

Email: [info@v5-group.com](mailto:info@v5-group.com)

Phone: +972-532-860901



**Note:** We reserve the right to make technical changes or modify the contents of this document without prior notice. With regard to purchase orders, the agreed particulars shall prevail. V5 GROUP Ltd. does not accept any responsibility whatsoever for potential errors or possible lack of information in this document.

We reserve all rights in this document and in the subject matter and illustrations contained therein. Any reproduction, disclosure to third parties or utilization of its contents – in whole or in parts – is forbidden without prior written consent of V5 GROUP Ltd.